

Name: _____
 Company: _____
 Cellular: _____
 Email: _____
 Distributor: _____

Job Date: _____
 Job Reference: _____
 Roofing System: TPO PVC NDL Job: Yes No
 If NDL, Rep Name: _____
 Color: White Tan Gray Slate Gray Dark Bronze

Note: For multiple sizes and/or colors use additional quote forms. Want to fill out faster? Go online FlashCoMfg.com/Edge-FlashForm

FLASHWRAP[®] - SPLIT BOOTS

Cylindrical Split Boot Qty: _____

Size
 1" 2" 3"
 4" 5" 6"
 Hose Clamp: Yes No

Made to actual size

Square/Rectangle Split Boot Qty: _____

Size
 2"x2"
 4"x4"

Standard corner radius is 1/8"

Conical Split Boot Qty: _____

Size Bantam .5-1 (1/2"-1")
 Welter 1-3 (1"-3")
 Middle 3-5 (3"-5")
 Cruiser 5-7 (5"-7")
 Super 7-9 (7"-9")
 Hose Clamp: Yes No

FLASHJACK[™] - CLOSED BOOTS

Conical Boot Qty: _____

Size Bantam .5-1 (1/2"-1")
 Welter 1-3 (1"-3")
 Middle 3-5 (3"-5")
 Cruiser 5-7 (5"-7")
 Super 7-9 (7"-9")
 Hose Clamp: Yes No

Molded Pipe Seal Qty: _____

Size 6 in 1 Pre-Molded Universal (hose clamp included)

Available in white only

For Custom Sizes:
 Use Custom Accessories FlashForm, or
 use Online FlashForm (FlashCoMfg.com/Edge-FlashForm)

FLASHDRAIN[™] - DRAINS

Retrofit Drain Qty: _____

Size
 2" 3" 4"
 5" 6"
 Fluted: Yes No
 Target Patch: Yes No

Scupper (Reinforced) Qty: _____

Size
 4"W x 4"H x 12"D x 6"F
 6"W x 4"H x 12"D x 6"F
 Throughwall Overflow
 Type: Center Corner

Drain Boot Qty: _____

Size 2" 3"

Membrane only

Drop Outlet Qty: _____

Size 2" 3"

Designed for external drainage

FLASHVENT[™] - VENT FLASHINGS

Easy Flapper[™] Qty: _____

Size
 4" 6" 8"

Add Boot: Yes No

Sub Base & Boot/Assembly Qty: _____

Size
 4" 4" Oval 6"
 8" 10" 12"
 Boot Assembly

Breather Vent Qty: _____

Size
 4" Round
 8" Square
 One Way
 Two Way

Gravity Vent Qty: _____

Size
 12"x12"
 18"x18"
 24"x24"

Louver Vent Qty: _____

Size
 14" x 18"
 12" x 12"
 14" x 12"

T-Top & Square Top Vents Qty: _____

Size
 4" T-Top
 6" T-Top
 8" T-Top
 8" Square Top
 4"x12" T-Top Box

Eyebrow Vent Qty: _____

Size 18" 24"
 For 45° - 90° slopes

Wall Vent Qty: _____

Size 12" 16" 24"
 For 90° applications

FlashCap[®] Vent Boot Qty: _____

Size
 1 1/2" 2"
 3" 4"

FLASHACCESSORY[™] - ACCESSORIES

Coated Metal Qty: _____

Size
 2"x4"x10'
 3"x3"x10'
 4' x 10' Full Sheet

Sealant Pocket Qty: _____

Pre-Fab Size
 4"x4" 6"x6" 8"x8"

Molded Size
 6" x 6"-12"

Corners Qty: _____

Size
 6" Inside Corner
 6" Outside Corner
 Fluted Outside
 Molded Inside/Outside

T-Joint Covers Qty: _____ 100/bag

Size
 4 1/2" Pre-Fab
 4 1/2" Molded

Name: _____
 Company: _____
 Cellular: _____
 Email: _____
 Distributor: _____

Job Date: _____
 Job Reference: _____
 Roofing System: TPO PVC NDL Job: Yes No
 If NDL, Rep Name: _____
 Color: White Tan Gray Slate Gray Dark Bronze

Note: For multiple sizes and/or colors use additional quote forms. Want to fill out faster? Go online FlashCoMfg.com/Edge-FlashForm

FLASHWRAP[®] - SPLIT BOOTS

Cylindrical Split Boot Qty: _____

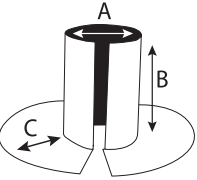

Custom Size
 A: Diam. _____ in.
 B: Height _____ in. (8" std.)
 C: Flange _____ in. (6" std.)
 Hose Clamp: Yes No

Square/Rect. Split Boot Qty: _____

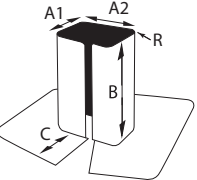

Custom Size
 A1: Tube: _____ in.
 A2: Tube: _____ in.
 B: Height _____ in. (8" std.)
 C: Flange _____ in. (6" std.)
 R: Radius _____ in. (1/8" std.)

Conical Split Boot Qty: _____

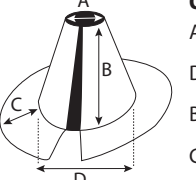

Custom Size
 A: Top Dia. _____ in.
 D: Btm Dia. _____ in.
 B: Height _____ in. (8" std.)
 C: Flange _____ in. (6" std.)
 Hose Clamp: Yes No

FLASHJACK[™] - CLOSED BOOTS

Cylindrical Boot Qty: _____

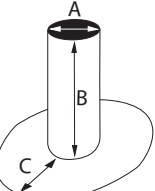

Custom Size
 A: Diam. _____ in.
 B: Height _____ in. (8" std.)
 C: Flange _____ in. (6" std.)
 Hose Clamp: Yes No

Built to size

Square/Rect. Boot Qty: _____

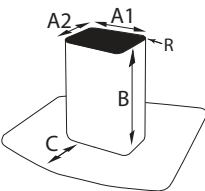

Custom Size
 A1: Tube: _____ in.
 A2: Tube: _____ in.
 B: Height _____ in. (8" std.)
 C: Flange _____ in. (6" std.)
 R: Radius _____ in. (1/8" std.)

Built to size

Conical Boot Qty: _____

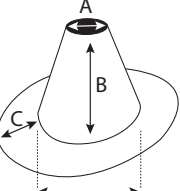

Custom Size
 A: Top Diam. _____ in.
 D: Btm Diam. _____ in.
 B: Height _____ in. (8" std.)
 C: Flange _____ in. (6" std.)
 Hose Clamp: Yes No

FLASHDRAIN[™] - DRAINS

Scupper Qty: _____

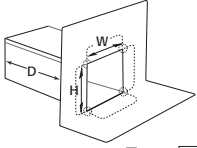

Custom Size
 W: Width _____ in.
 H: Height _____ in.
 D: Depth _____ in.
 Throughwall Overflow
 Type: Center R. Corner L. Corner

Sealant Pocket Qty: _____

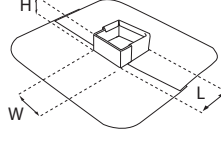

Custom Size
 W: Width _____ in.
 L: Length _____ in.
 H: Height _____ in. (2" std.)

Split side is along L

Curb Wrap Qty: _____

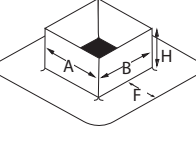

Configuration
 2 pcs 4 pcs
 Split Closed
 A: Dim. _____ in.
 B: Dim. _____ in.
 H: Height _____ in. (8" & 12" std.)
 F: Flange _____ in. (6" std.)

FLASHEDGE[™] - COATED METAL

Drip Edge Qty: _____

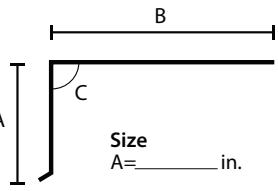

Options
 No Hem
 Hem Open
 Hem Closed
 Hem Return _____ in.

Size
 A = _____ in.
 B = _____ in.
 C = _____ deg.

Gravel Stop Drip Edge Qty: _____

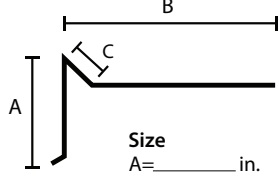

Options
 No Hem
 Hem Open
 Hem Closed
 Hem Return _____ in.

Size
 A = _____ in.
 B = _____ in.
 C = _____ in.

Cleat Qty: _____

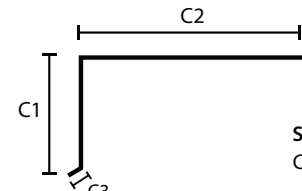

Size
 C1 = _____ in.
 C2 = _____ in.
 C3 = _____ in.

Cleat fits in Open Hem

Cap Metal Qty: _____

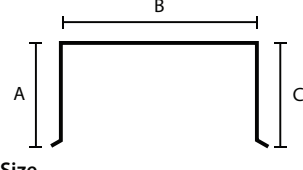

Options
 No Hem
 Hem Open
 Hem Closed
 Hem Return _____ in.

Size
 A = _____ in. B = _____ in. C = _____ in.

Z Bar Qty: _____

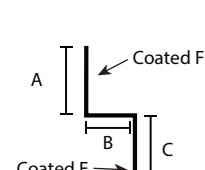

Size
 A = _____ in.
 B = _____ in.
 C = _____ in.
 Coated Side: E F

Roof To Wall/Starter Qty: _____

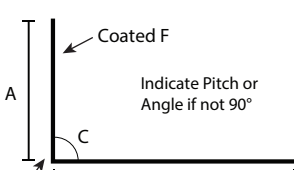

Size
 A = _____ in.
 B = _____ in.
 C = _____ deg.
 Coated Side: E F

Indicate Pitch or Angle if not 90°

Name: _____ Distributor: _____

Company: _____ Job Name: _____

Cellular: _____ Job Location: _____

Email: _____ Job Date: _____

Choose Options:

Type: TPO PVC

Color: White Tan Gray

Other: _____

Talk with your FlashCo Representative for special orders & material availability.

Notes:

- 6" standard reinforced membrane skirt with 3" of weldable flange beyond the tabs
- Standard 3" metal tabs for fastening to wall and deck
- Throat is coated 24g G90 steel

Throughwall Scupper (Center)

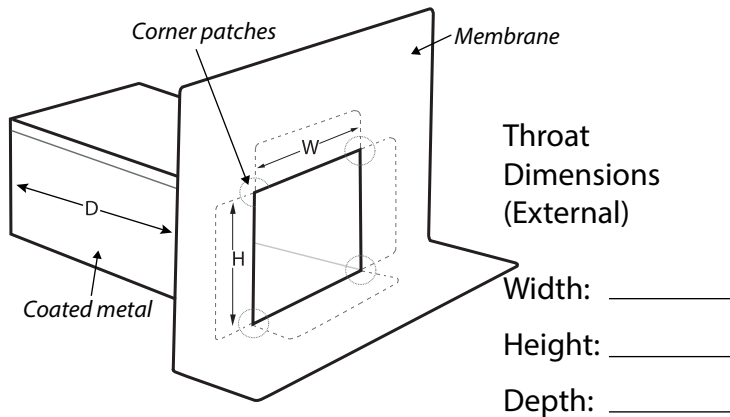

Weldable Memb. Flange (3" std.): _____ Qty. _____

Overflow Scupper

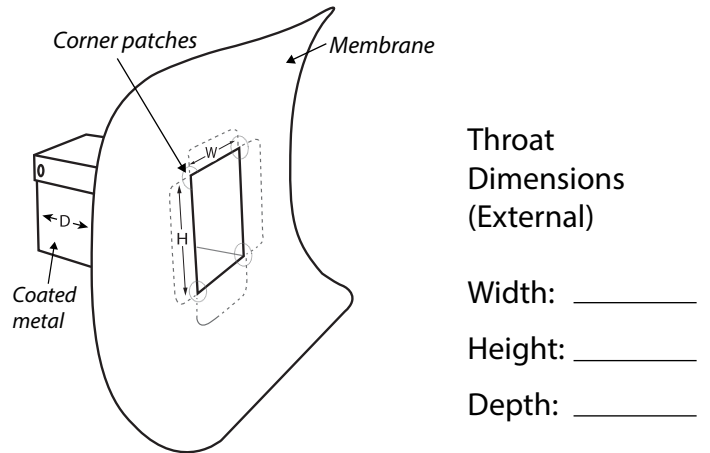

Weldable Memb. Flange (3" std.): _____ Qty. _____

Throughwall Scupper (Left Corner)

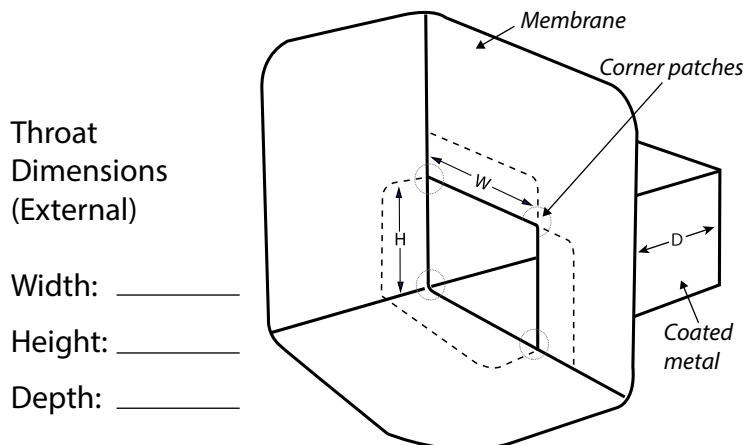

Qty. _____ Weldable Memb. Flange (3" std.): _____

Throughwall Scupper (Right Corner)

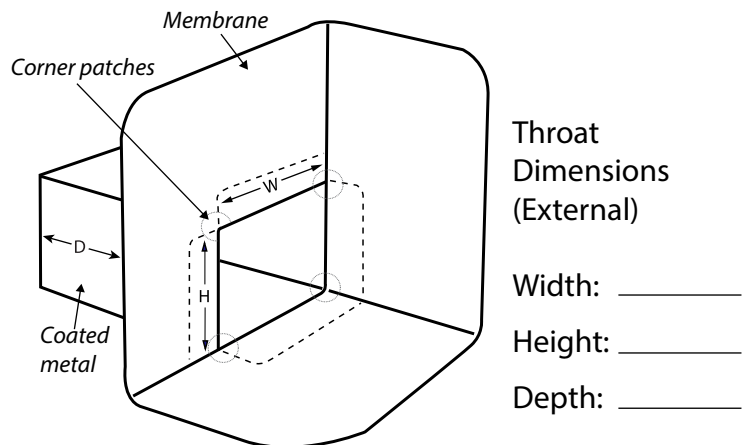

Weldable Memb. Flange (3" std.): _____ Qty. _____

Name: _____ Distributor: _____

Company: _____ Job Name: _____

Cellular: _____ Job City & State: _____

Email: _____ Job Date: _____

Choose Options:

Type: TPO PVC

Color: White Tan Gray

Dark Bronze Slate Gray

Other: _____

Talk with your FlashCo Representative for special orders & material availability.

Notes:

- All lengths of metal are 10' unless otherwise stated.
- Kick and hem are both included in pullout total measurement
- Standard edge is 3/8" and 30° away from the vertical.
- Sold in bundles of 10.

Drip Edge

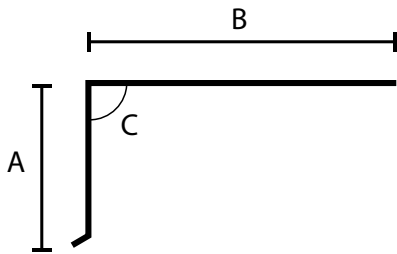

Size
A= _____ in.
B= _____ in.
C= _____ deg.

Options
 No Hem
 Hem Open
 Hem Closed

Quantity _____

Hem Return _____ in.

Gravel Stop Drip Edge

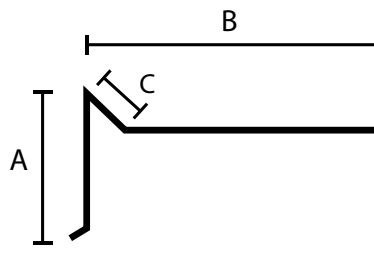

Size
A= _____ in.
B= _____ in.
C= _____ in.

Options
 No Hem
 Hem Open
 Hem Closed

Quantity _____

Hem Return _____ in.

Cleat

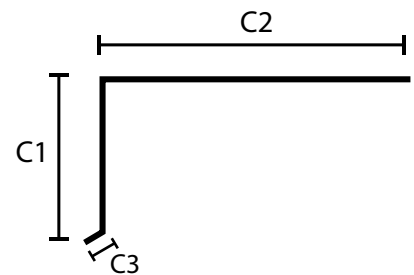

Size
C1= _____ in.
C2= _____ in.
C3= _____ in.

Quantity _____

Cleat fits in Open Hem

Cap Metal

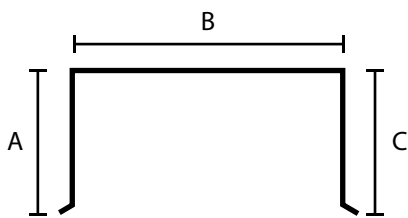

Size
A= _____ in.
B= _____ in.
C= _____ in.

Options
 No Hem
 Hem Open
 Hem Closed

Quantity _____

Hem Return _____ in.

Z Bar

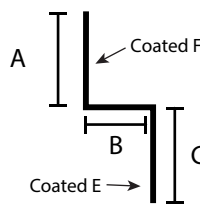

Size
A= _____ in.
B= _____ in.
C= _____ in.

Quantity _____

Coated Side:
 E F

Roof To Wall/Starter

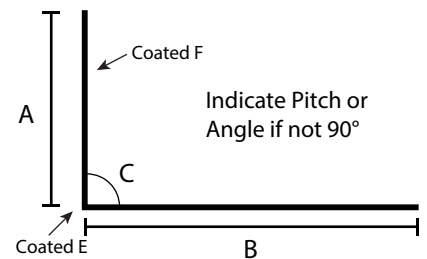

Size
A= _____ in.
B= _____ in.
C= _____ deg.

Quantity _____

Coated Side:
 E F

Indicate Pitch or Angle if not 90°